

# Conditional Execution

## Chapter 3



Python for Informatics: Exploring Information  
[www.py4inf.com](http://www.py4inf.com)

open.michigan

Unless otherwise noted, the content of this course material is licensed under a Creative Commons Attribution 3.0 License.

<http://creativecommons.org/licenses/by/3.0/>.

Copyright 2010- Charles R. Severance

# Conditional Steps

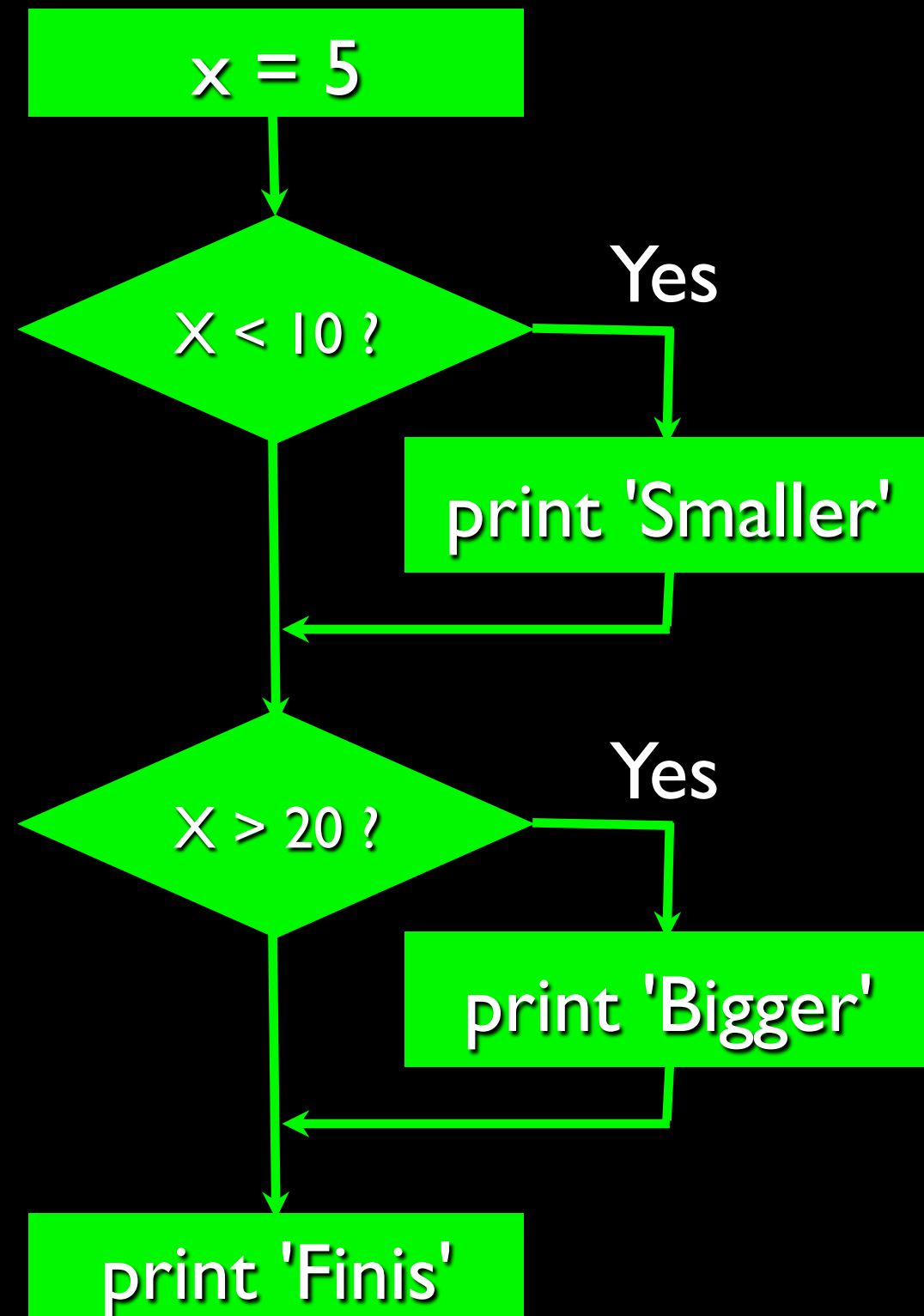

Program:

```
x = 5
```

```
if x < 10:
```

```
    print 'Smaller'
```

```
if x > 20:
```

```
    print 'Bigger'
```

```
print 'Finis'
```

Output:

Smaller

Finis

# Comparison Operators

- **Boolean expressions** ask a question and produce a Yes or No result which we use to control program flow
- **Boolean expressions** using **comparison operators** evaluate to - True / False - Yes / No

Python	Meaning
<	Less than
<=	Less than or Equal
==	Equal to
>=	Greater than or Equal
>	Greater than
!=	Not equal

- **Comparison operators** look at variables but **do not change** the variables

Remember: “=” is used for assignment.

[http://en.wikipedia.org/wiki/George\\_Boole](http://en.wikipedia.org/wiki/George_Boole)

# Comparison Operators

```
x = 5
if x == 5 :
    print 'Equals 5'
if x > 4 :
    print 'Greater than 4'
if x >= 5 :
    print 'Greater than or Equal 5'
if x < 6 : print 'Less than 6'
if x <= 5 :
    print 'Less than or Equal 5'
if x != 6 :
    print 'Not equal 6'
```

Equals 5  
Greater than 4  
Greater than or Equal 5  
Less than 6  
Less than or Equal 5  
Not equal 6



```
x = 5
print 'Before 5'
if x == 5 :
    print 'Is 5'
    print 'Is Still 5'
    print 'Third 5'
print 'Afterwards 5'
print 'Before 6'
if x == 6 :
    print 'Is 6'
    print 'Is Still 6'
    print 'Third 6'
print 'Afterwards 6'
```

Before 5  
Is 5  
Is Still 5  
Third 5  
Afterwards 5  
Before 6  
Afterwards 6

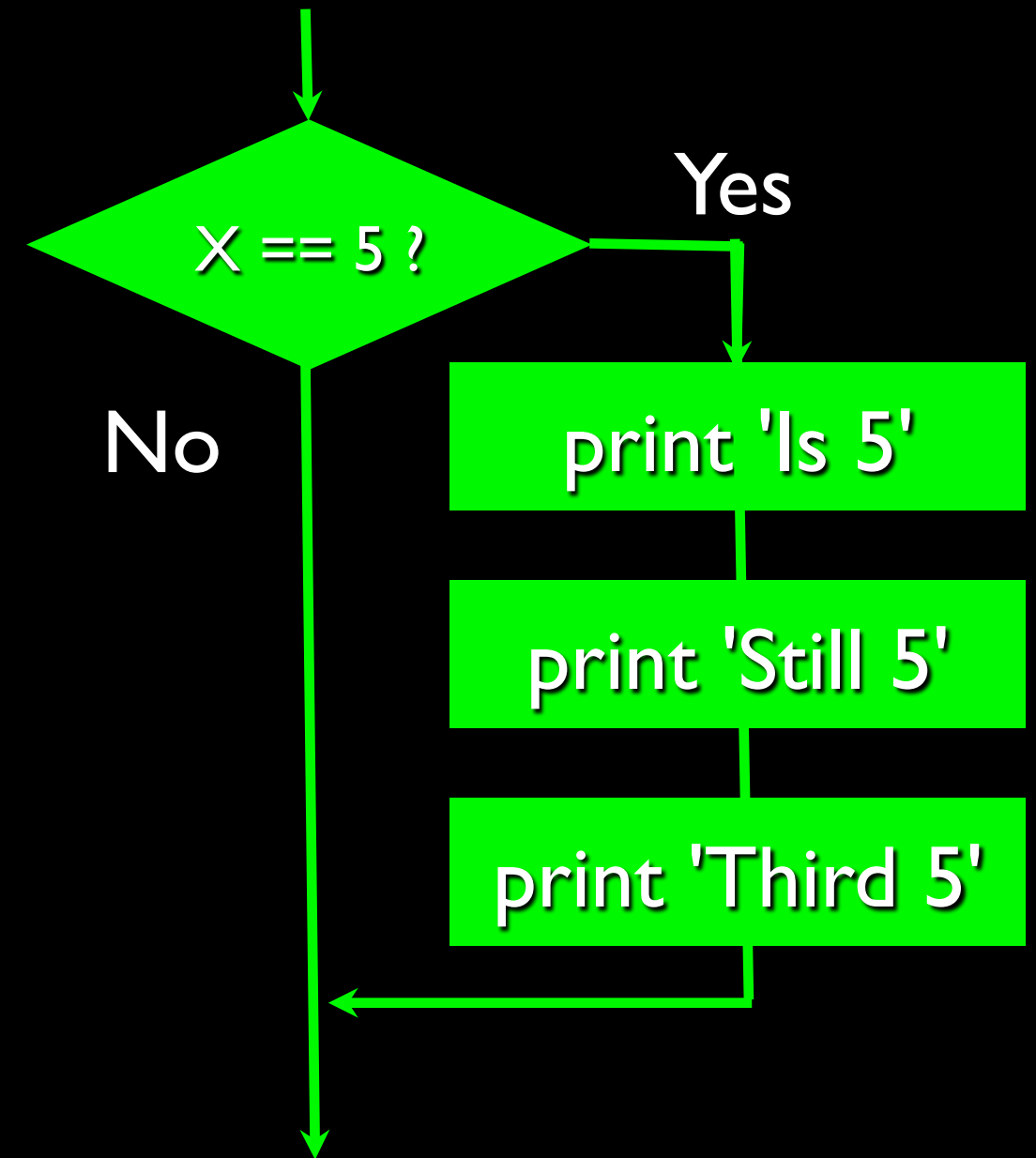

# One-Way Decisions

# Indentation

- **Increase indent** indent after an **if** statement or **for** statement (after : )
- **Maintain indent** to indicate the **scope** of the block (which lines are affected by the **if/for**)
- **Reduce indent** to **back to** the level of the **if** statement or **for** statement to indicate the end of the block
- **Blank lines** are ignored - they do not affect **indentation**
- **Comments** on a line by themselves are ignored w.r.t. **indentation**

# Warning: Turn Off Tabs

- Most text editors can turn **tabs** into **spaces** - make sure to enable this feature
- Notepad++: Settings -> Preferences -> Language Menu/**Tab** Settings
- TextWrangler: TextWrangler -> Preferences -> Editor Defaults
- Python cares a *\*lot\** about how far line is **indented**. If you mix **tabs** and **spaces**, you may get “**indentation errors**” even if everything looks fine

Please do this now while you are thinking about it so we can all stay sane...



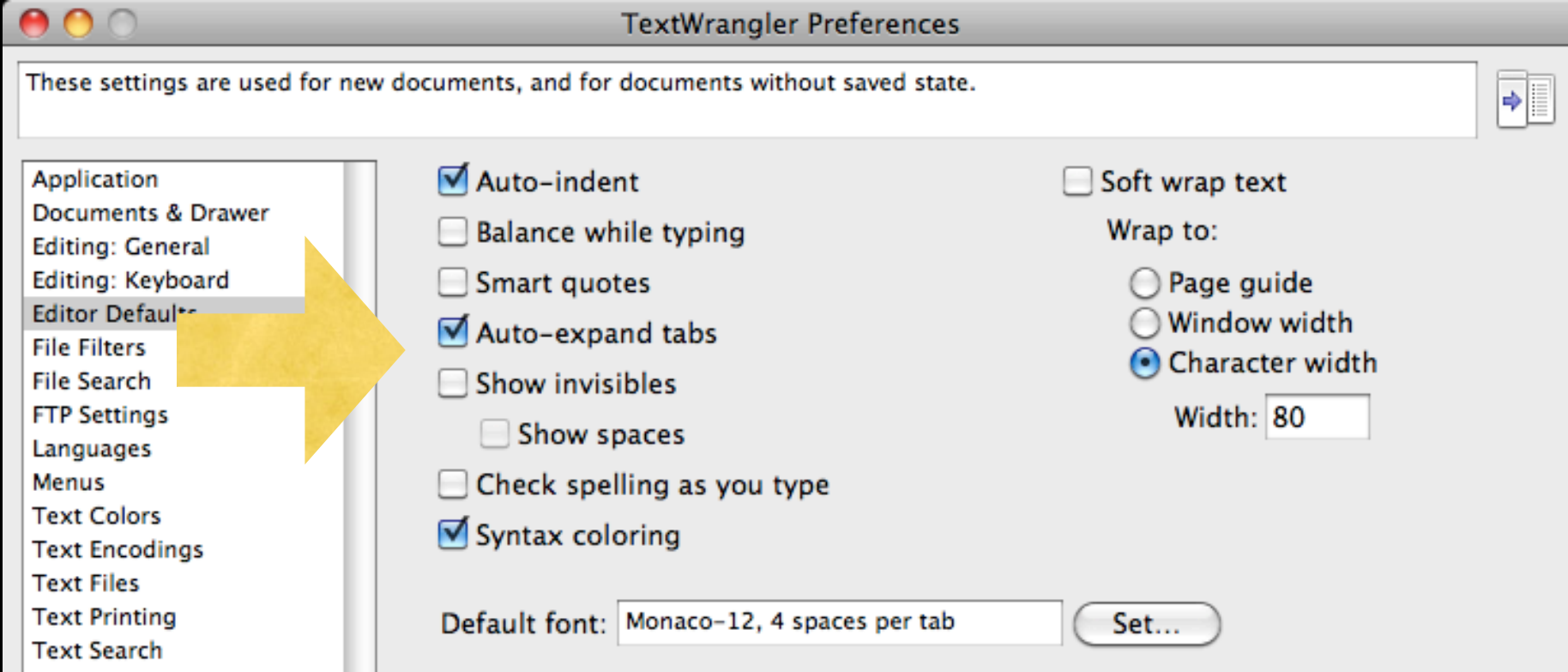

This will save you  
much unnecessary  
pain.

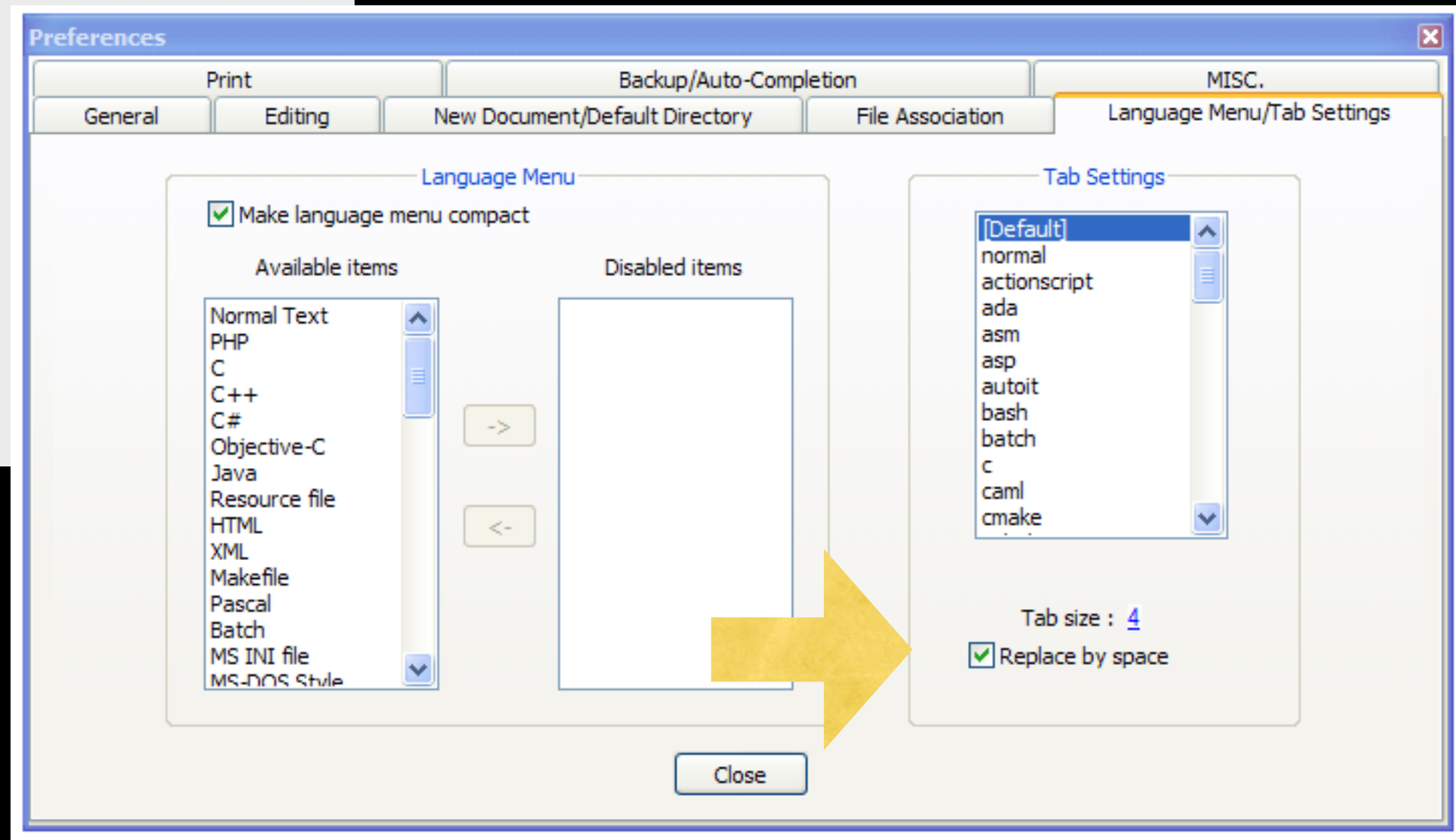

increase / maintain after if or for  
decrease to indicate end of block  
blank lines and comment lines ignored

```
x = 5
if x > 2 :
    print 'Bigger than 2'
    print 'Still bigger'
print 'Done with 2'

for i in range(5) :
    print i
    if i > 2 :
        print 'Bigger than 2'
    print 'Done with i',i
```

```
x = 5
if x > 2 :
    # comments

    print 'Bigger than 2'
    # don't matter
    print 'Still bigger'
    # but can confuse you

print 'Done with 2'
    # if you don't line
    # them up
```

# Mental begin/end squares

```
x = 5
```

```
if x > 2:
```

```
    print 'Bigger than 2'
```

```
    print 'Still bigger'
```

```
print 'Done with 2'
```

```
for i in range(5):
```

```
    print i
```

```
    if i > 2:
```

```
        print 'Bigger than 2'
```

```
    print 'Done with i', i
```

```
x = 5
```

```
if x > 2:
```

```
    # comments
```

```
        print 'Bigger than 2'
```

```
            # don't matter
```

```
        print 'Still bigger'
```

```
    # but can confuse you
```

```
print 'Done with 2'
```

```
    # if you don't line
```

```
        # them up
```

# Nested Decisions

$x = 42$

if  $x > 1$  :

    print 'More than one'

    if  $x < 100$  :

        print 'Less than 100'

print 'All done'

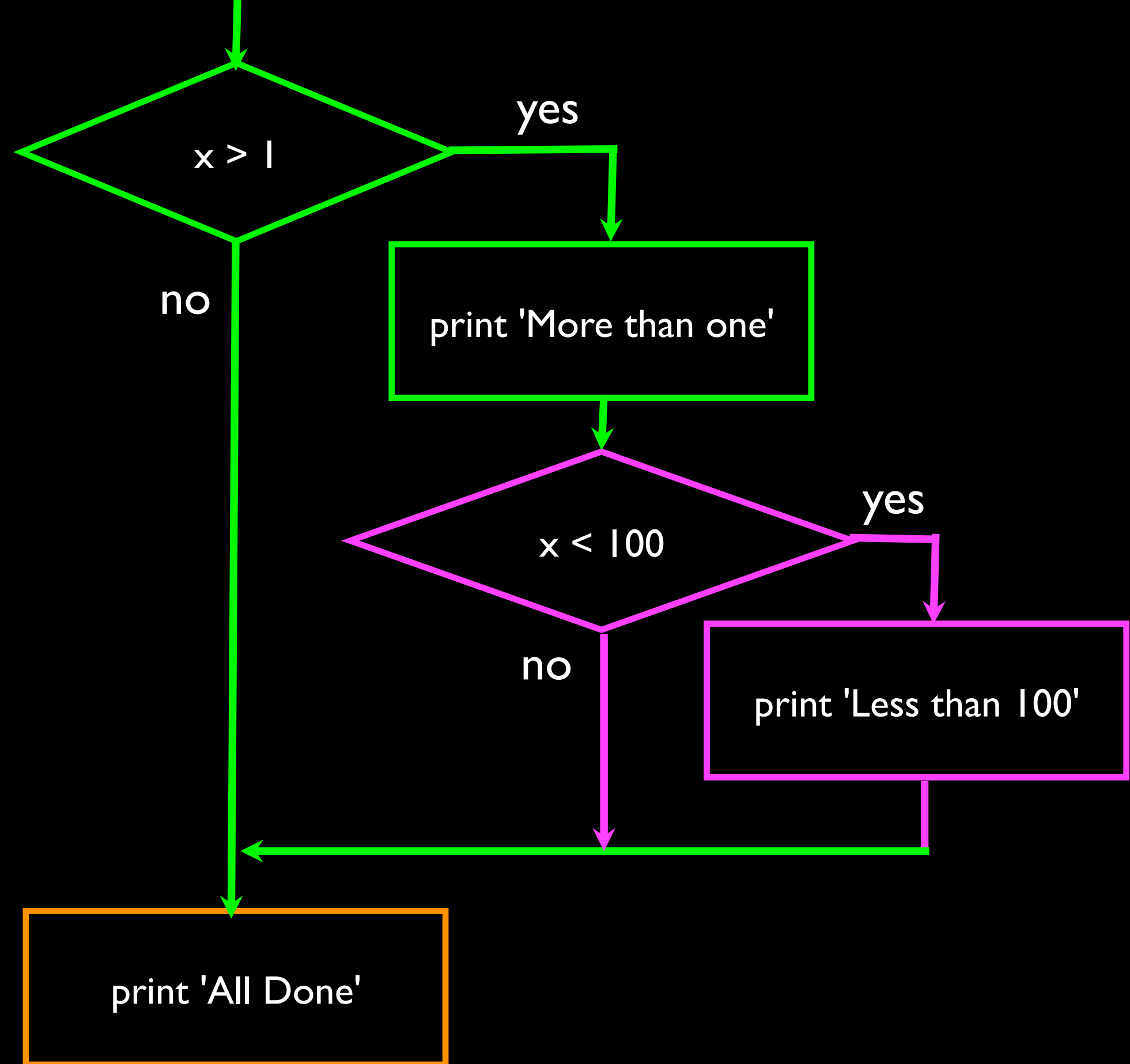

# Nested Decisions

$x = 42$

if  $x > 1$ :

print 'More than one'

if  $x < 100$ :

print 'Less than 100'

print 'All done'

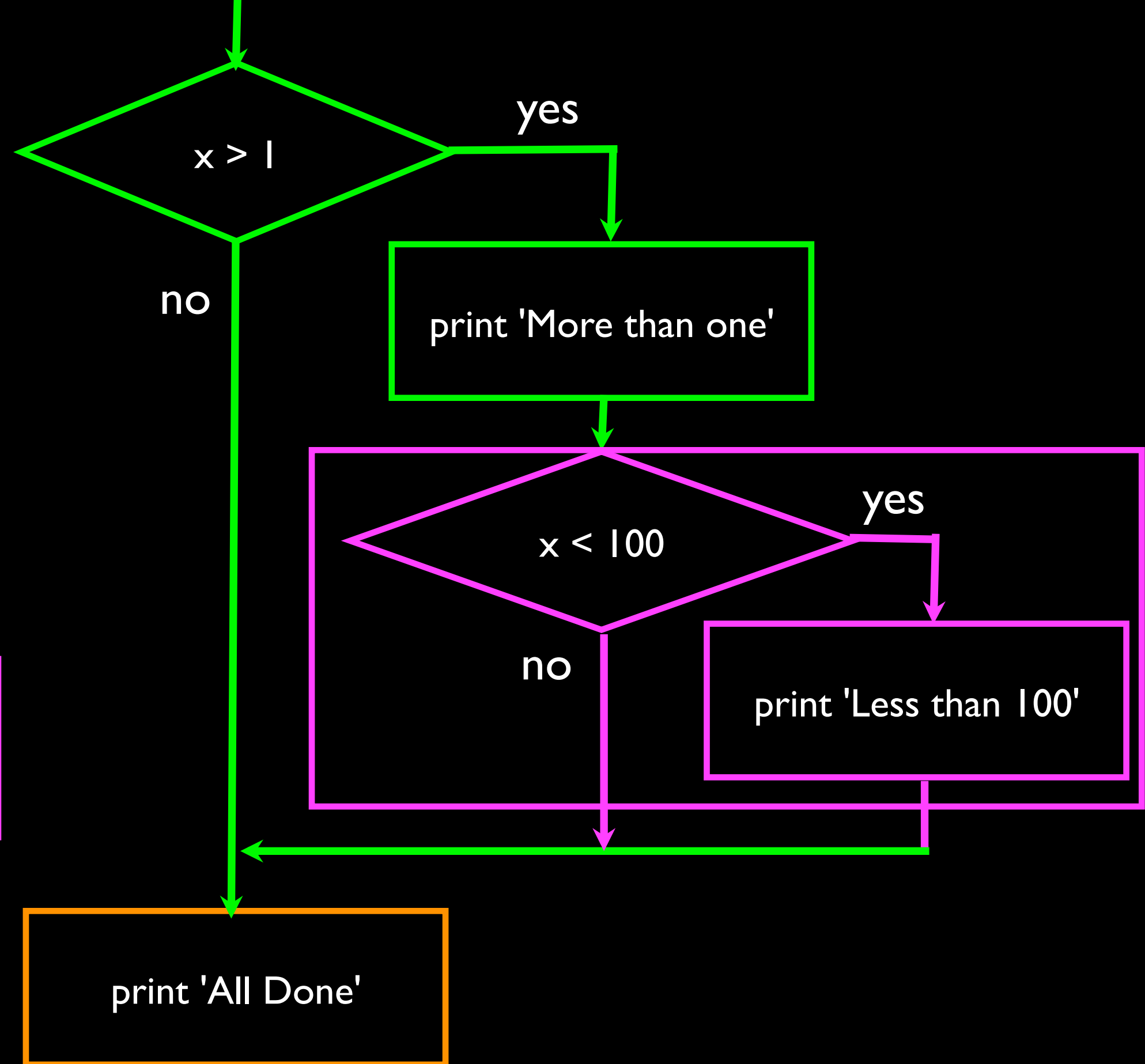

# Nested Decisions

$x = 42$

```
if  $x > 1$  :  
    print 'More than one'  
    if  $x < 100$  :  
        print 'Less than 100'
```

print 'All done'

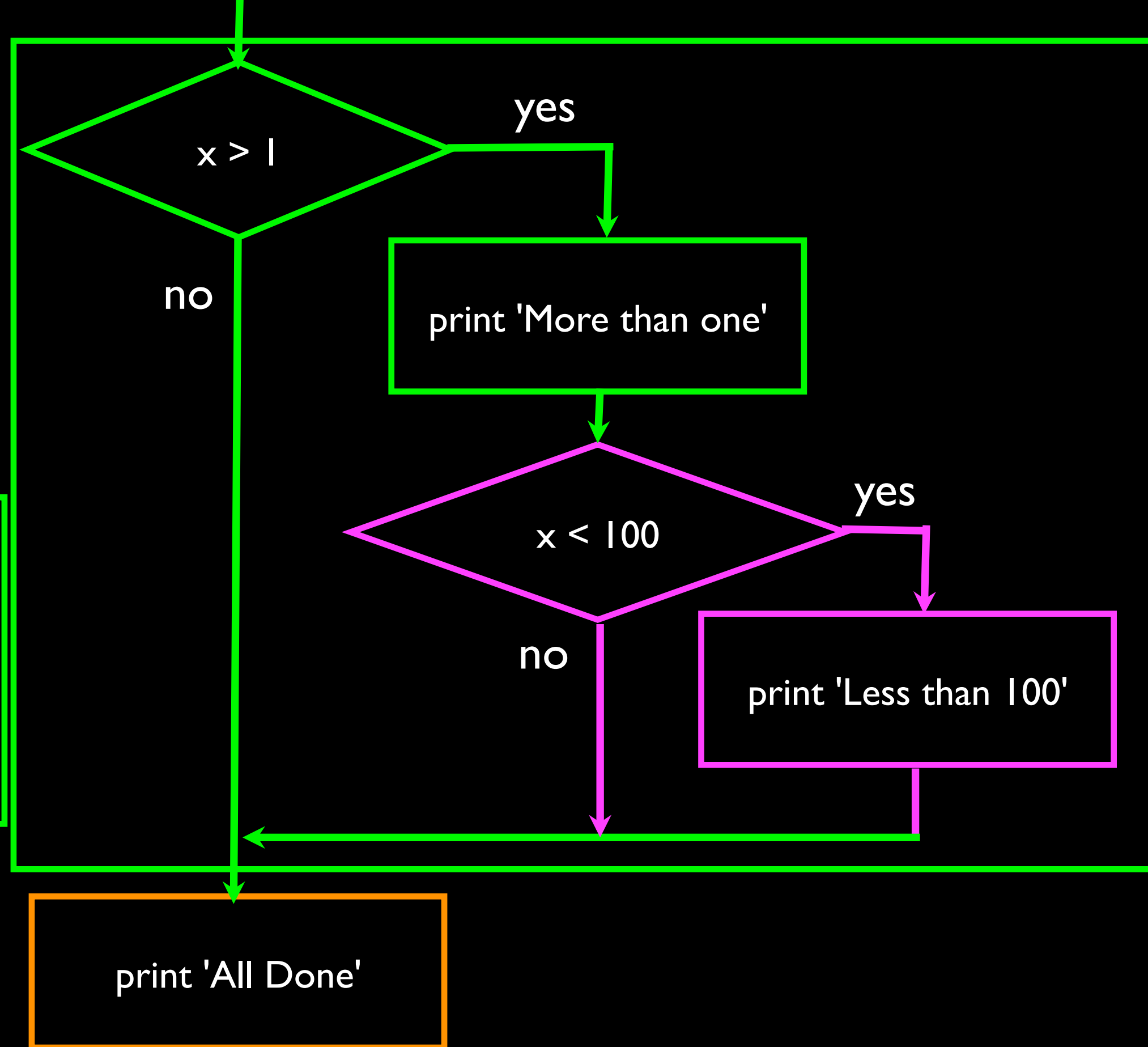

# Two Way Decisions

- Sometimes we want to do one thing if a logical expression is true and something else if the expression is false
- It is like a fork in the road - we must choose **one or the other** path but not both

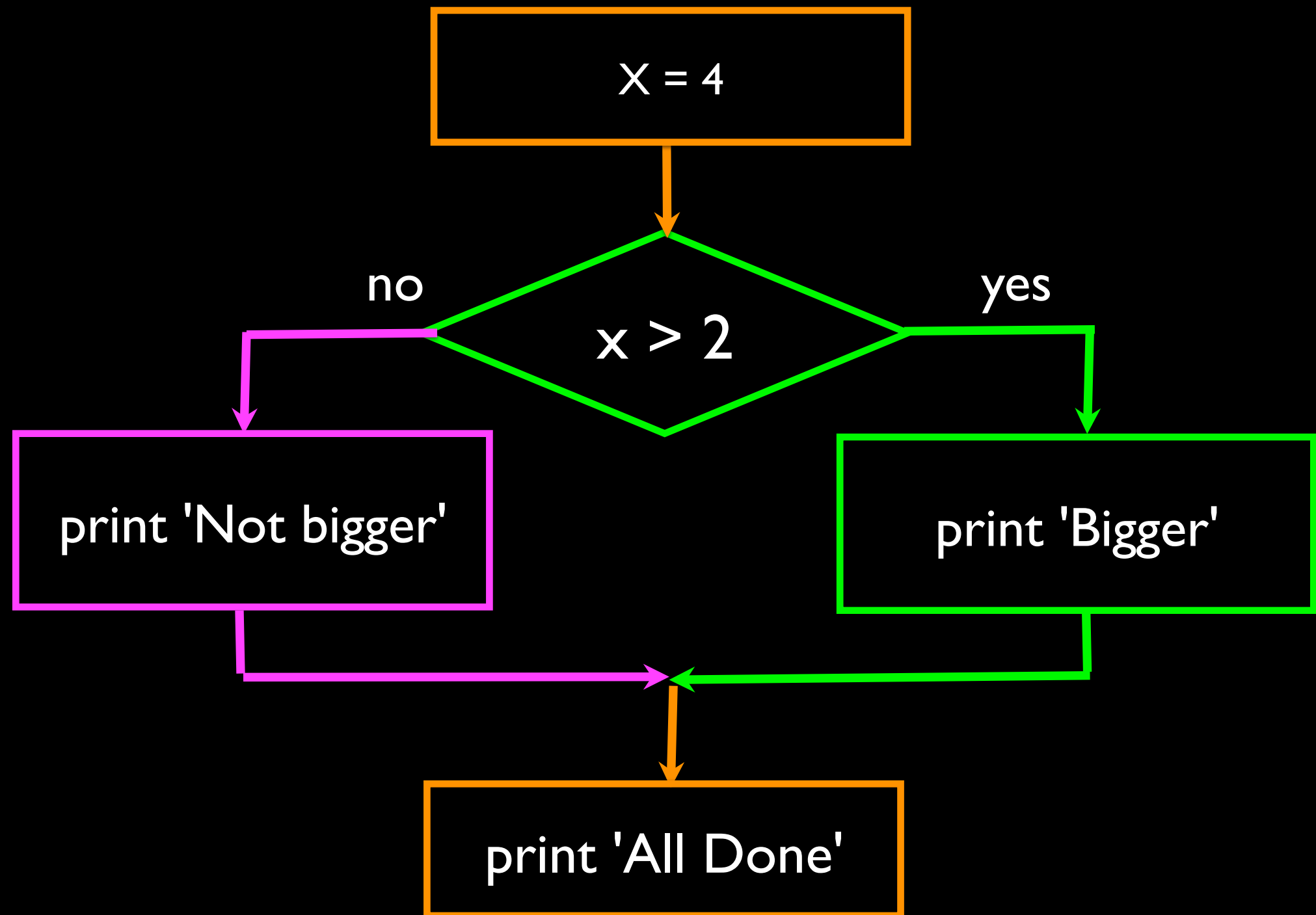

# Two-way using else :

$x = 4$

if  $x > 2$  :

    print 'Bigger'

else :

    print 'Smaller'

print 'All done'

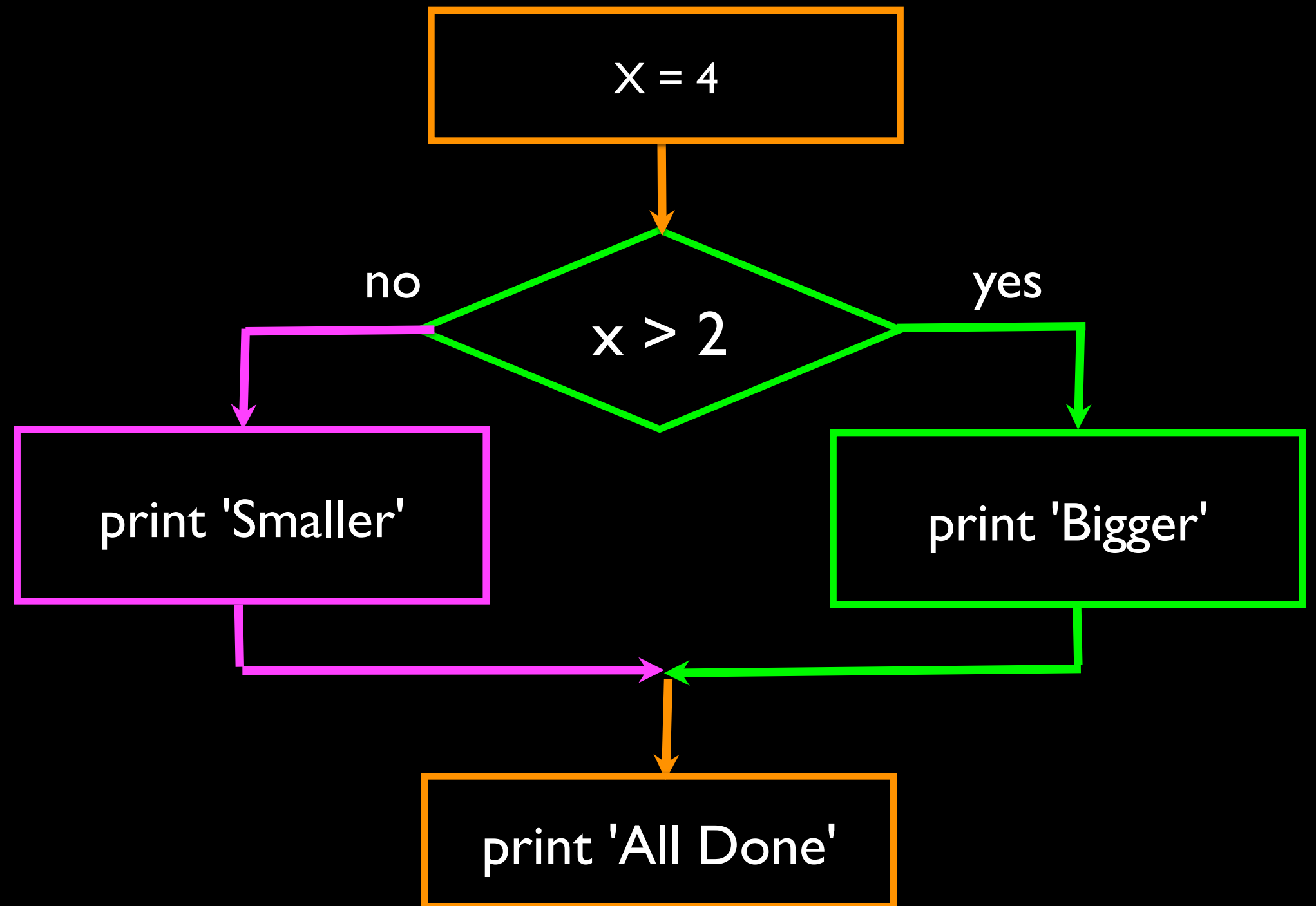



# Two-way using else :

x = 4

```
if x > 2:  
    print 'Bigger'  
else:  
    print 'Smaller'
```

print 'All done'

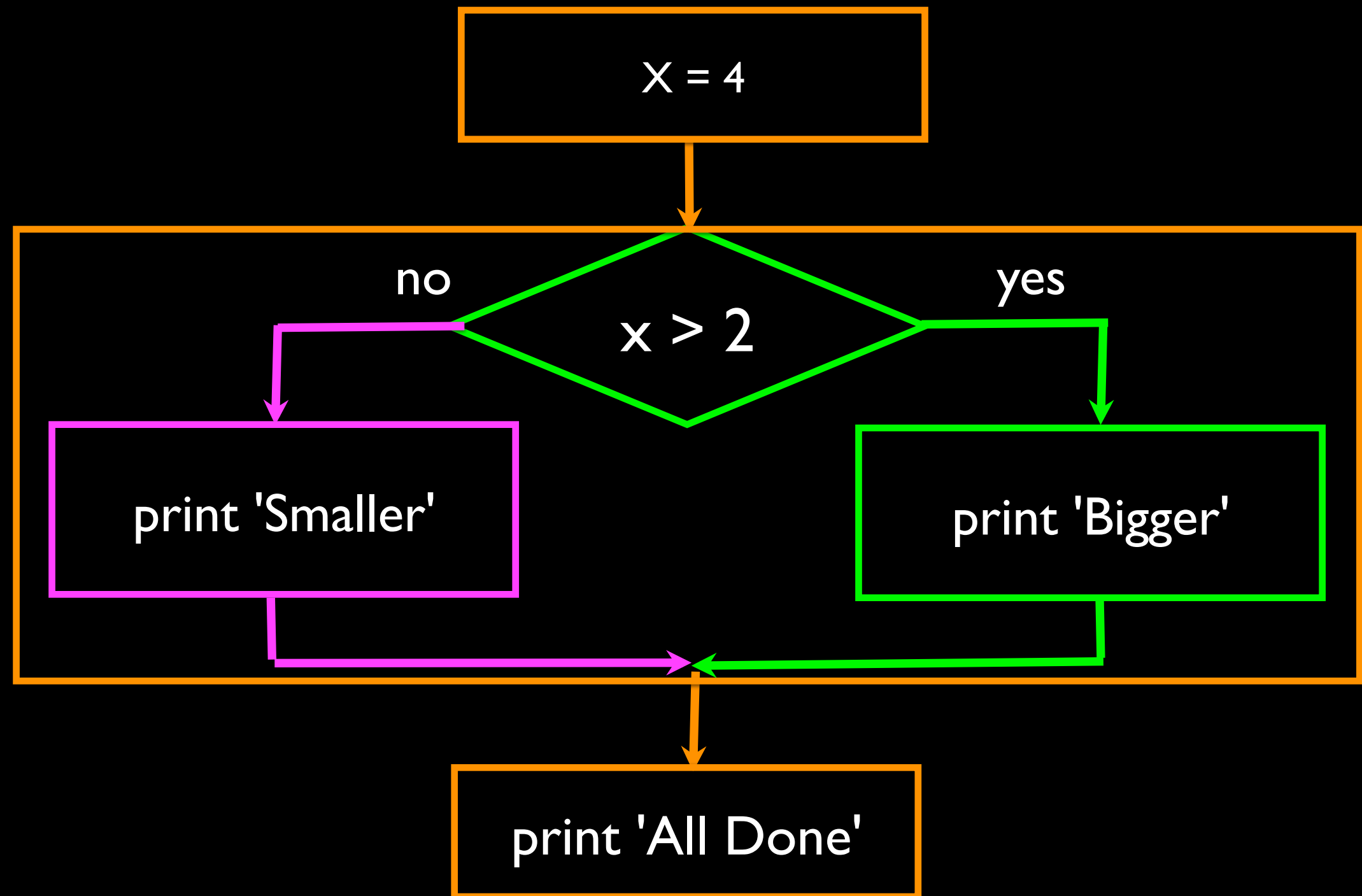

# Multi-way

```
if x < 2 :  
    print 'Small'  
elif x < 10 :  
    print 'Medium'  
else :  
    print 'LARGE'  
print 'All done'
```

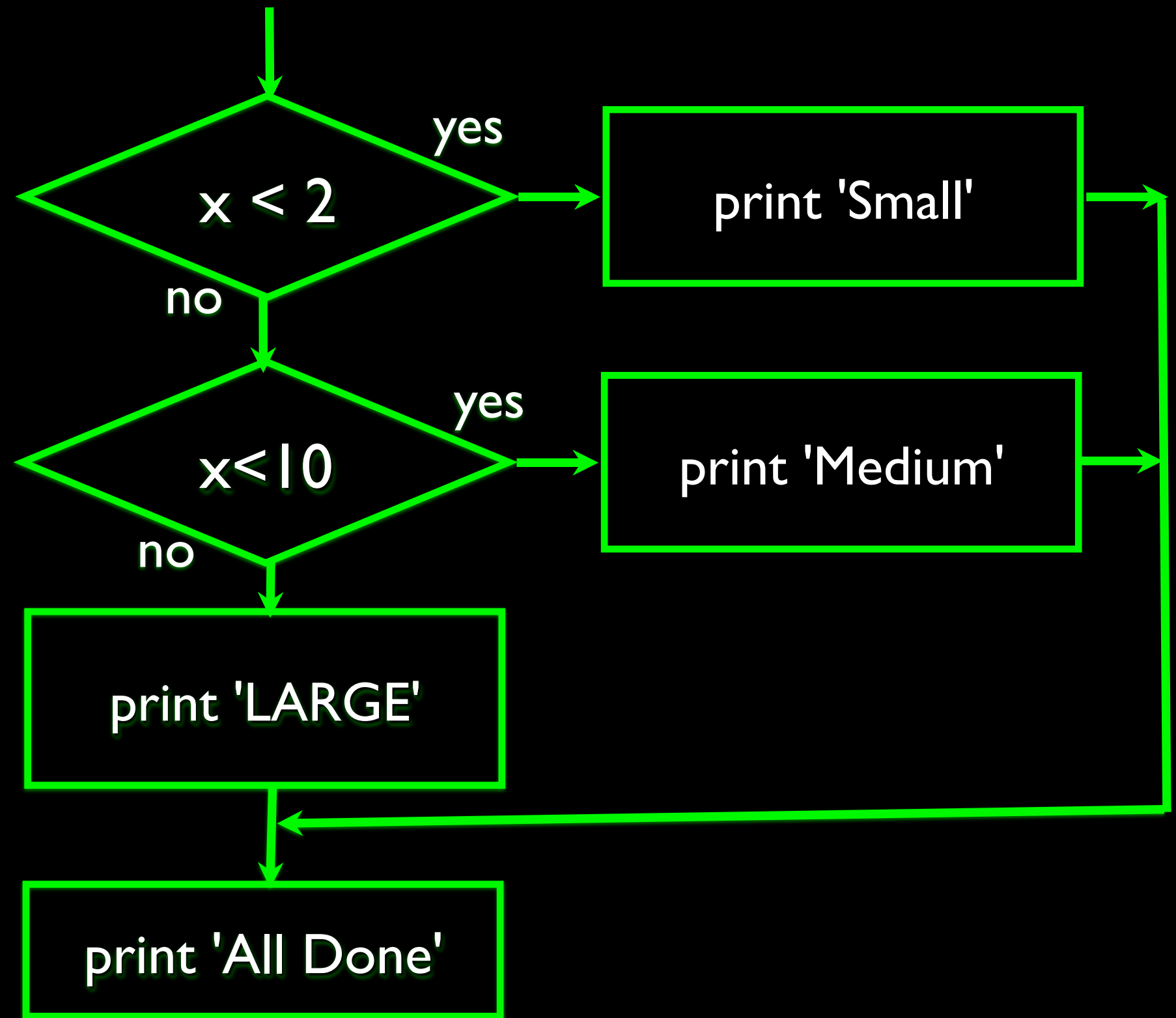

# Multi-way

```
x = 0
if x < 2 :
    print 'Small'
elif x < 10 :
    print 'Medium'
else :
    print 'LARGE'
print 'All done'
```

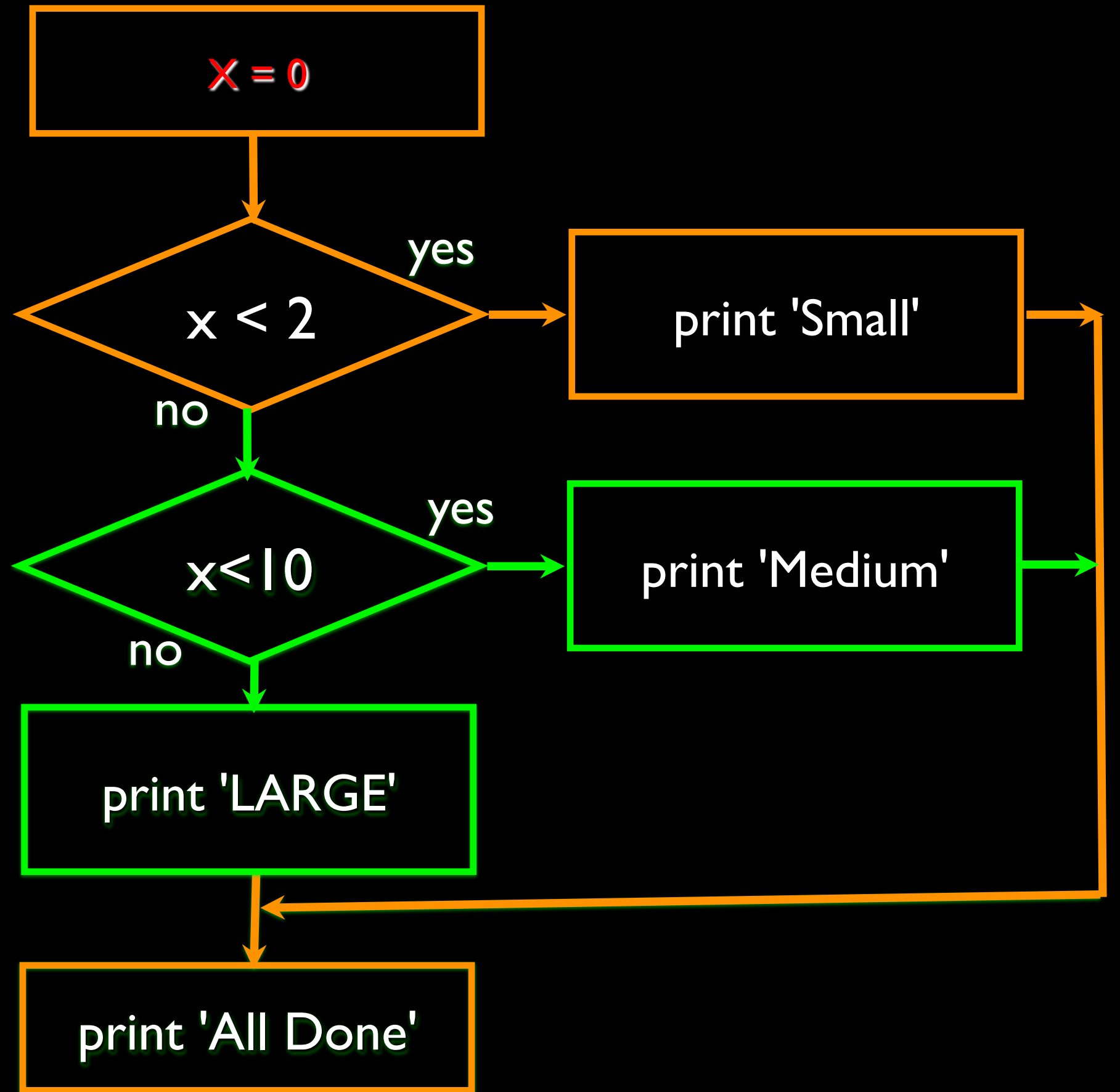

# Multi-way

```
x = 5
if x < 2 :
    print 'Small'
elif x < 10 :
    print 'Medium'
else :
    print 'LARGE'
print 'All done'
```

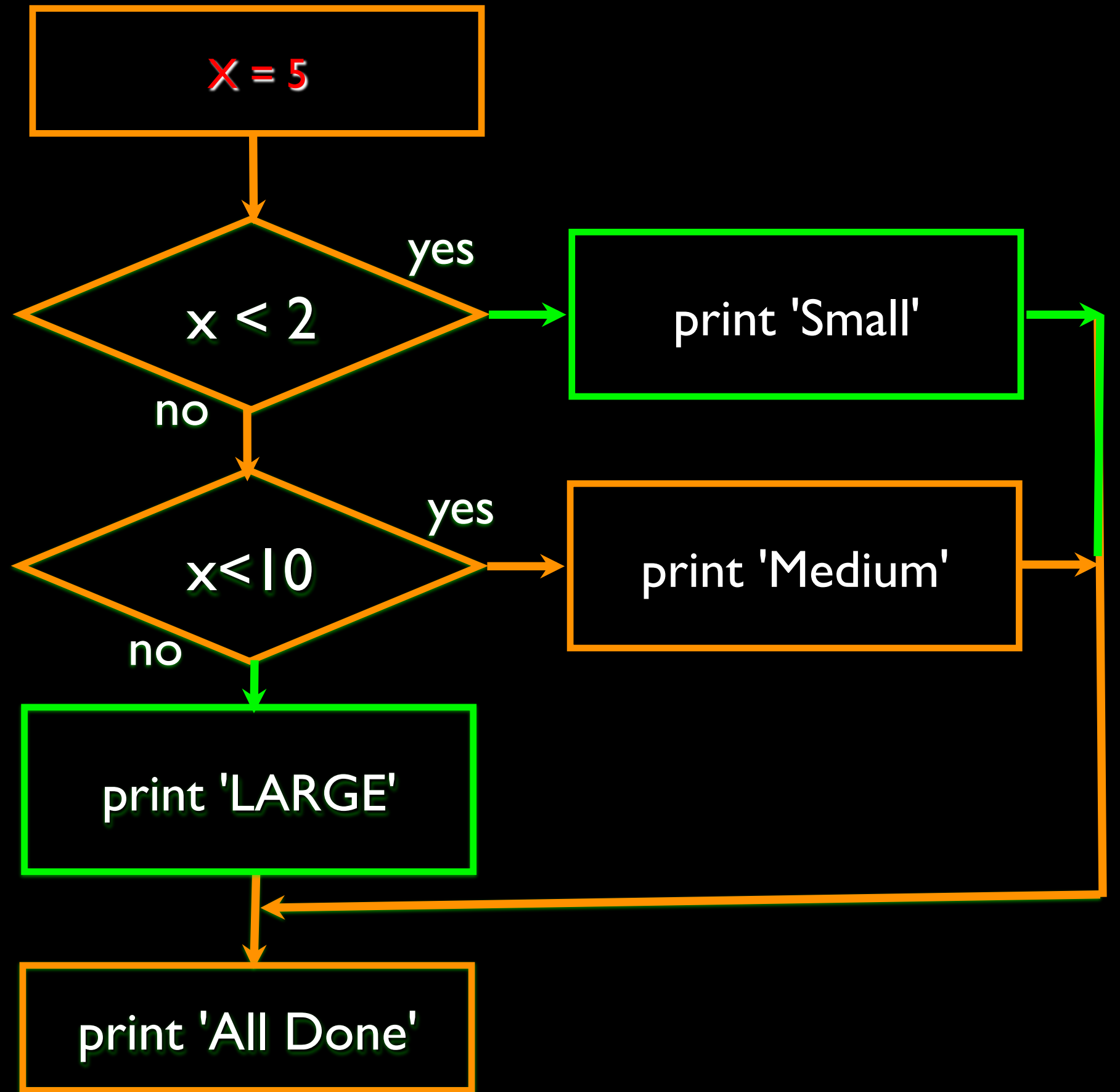

# Multi-way

```
x = 20
if x < 2 :
    print 'Small'
elif x < 10 :
    print 'Medium'
else :
    print 'LARGE'
print 'All done'
```

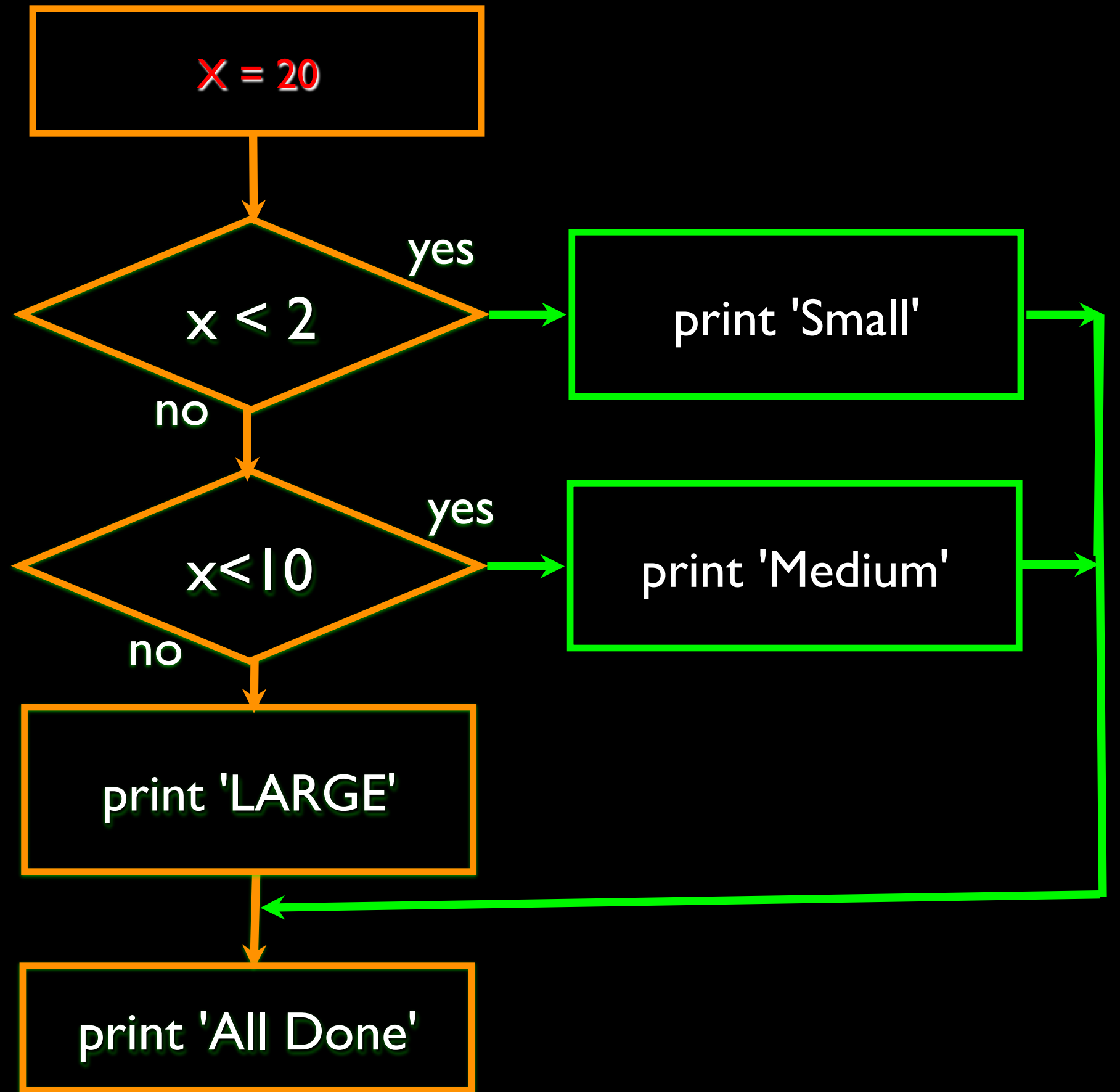

# Multi-way

```
# No Else
x = 5
if x < 2 :
    print 'Small'
elif x < 10 :
    print 'Medium'

print 'All done'
```

```
if x < 2 :
    print 'Small'
elif x < 10 :
    print 'Medium'
elif x < 20 :
    print 'Big'
elif x < 40 :
    print 'Large'
elif x < 100:
    print 'Huge'
else :
    print 'Ginormous'
```

# Multi-way Puzzles

Which will never print?

```
if x < 2 :  
    print 'Below 2'  
elif x >= 2 :  
    print 'Two or more'  
else :  
    print 'Something else'
```

```
if x < 2 :  
    print 'Below 2'  
elif x < 20 :  
    print 'Below 20'  
elif x < 10 :  
    print 'Below 10'  
else :  
    print 'Something else'
```

# The `try` / `except` Structure

- You surround a dangerous section of code with `try` and `except`.
- If the code in the `try` works - the `except` is skipped
- If the code in the `try` fails - it jumps to the `except` section



```
$ cat notry.py
astr = 'Hello Bob'
istr = int(astr)
print 'First', istr
astr = '123'
istr = int(astr)
print 'Second', istr
```

```
$ python notry.py Traceback (most
recent call last): File "notry.py", line 2,
in <module>   istr = int(astr)
ValueError: invalid literal for int() with
base 10: 'Hello Bob'
```



All  
Done

```
$ cat notry.py
astr = 'Hello Bob'
istr = int(astr)
```

→  
The  
program  
stops  
here

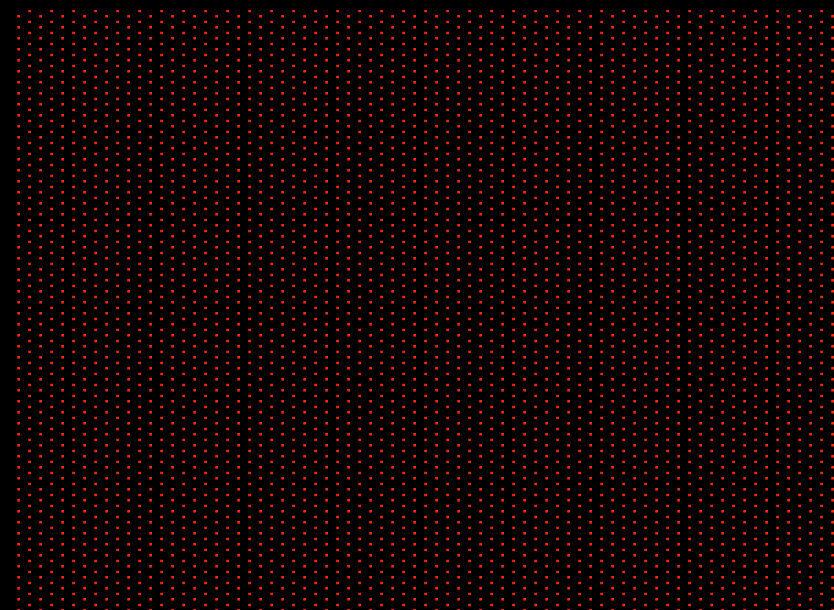

```
$ python notry.py
Traceback (most recent call last):
File "notry.py", line 2, in <module>
istr = int(astr)ValueError: invalid literal
for int() with base 10: 'Hello Bob'
```



All  
Done

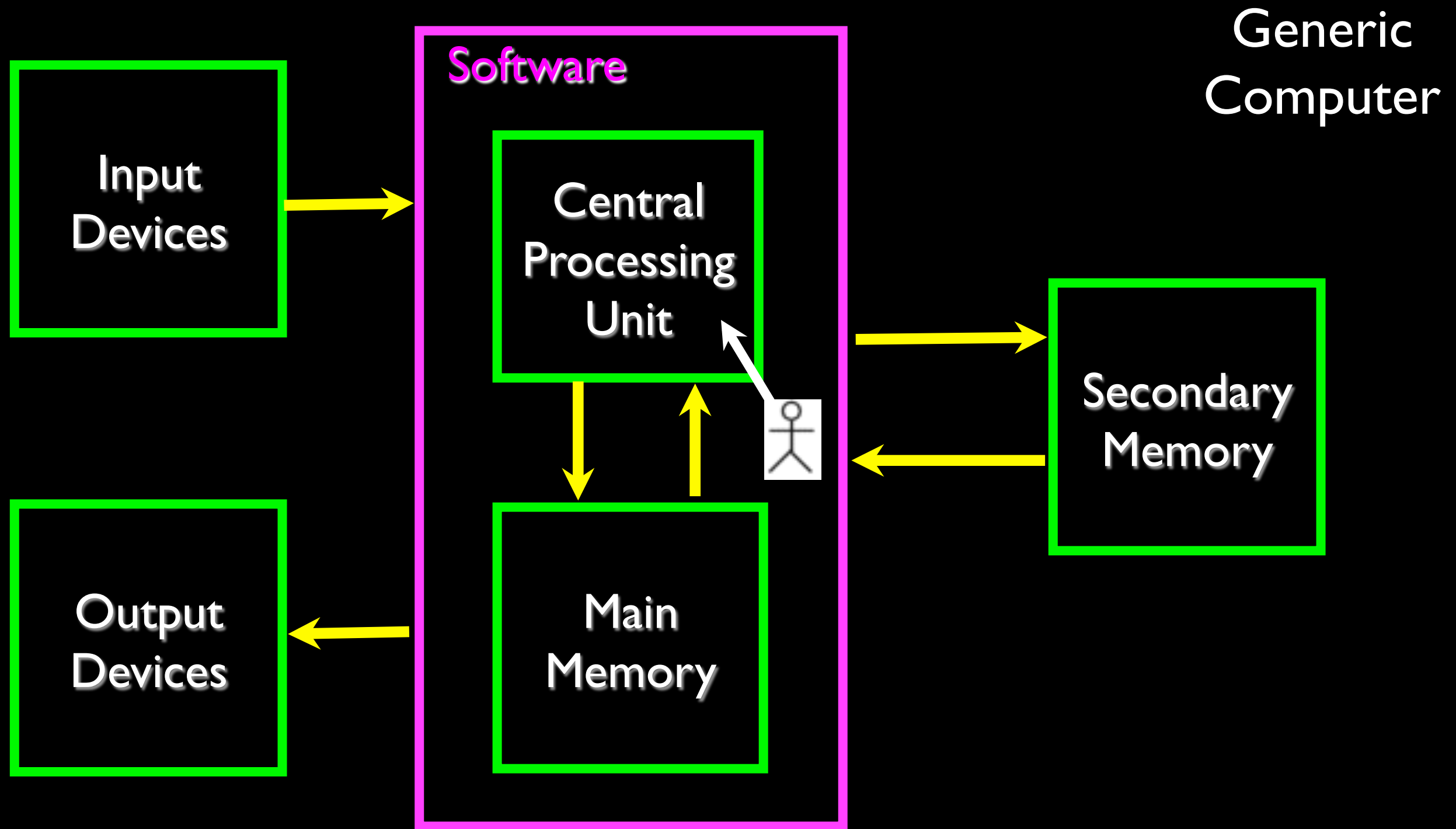

```
$ cat tryexcept.py
astr = 'Hello Bob'
try:
    istr = int(astr)
except:
    istr = -1
```



```
print 'First', istr
```

```
astr = '123'
```

```
try:
    istr = int(astr)
except:
    istr = -1
```



```
print 'Second', istr
```



When the first conversion fails - it just drops into the except: clause and the program continues.

```
$ python tryexcept.py
First -1
Second 123
```

When the second conversion succeeds - it just skips the except: clause and the program continues.

# try / except

```
astr = 'Bob'
```

```
try:
```

```
    print 'Hello'
```

```
    istr = int(astr)
```

```
    print 'There'
```

```
except:
```

```
    istr = -1
```

```
print 'Done', istr
```

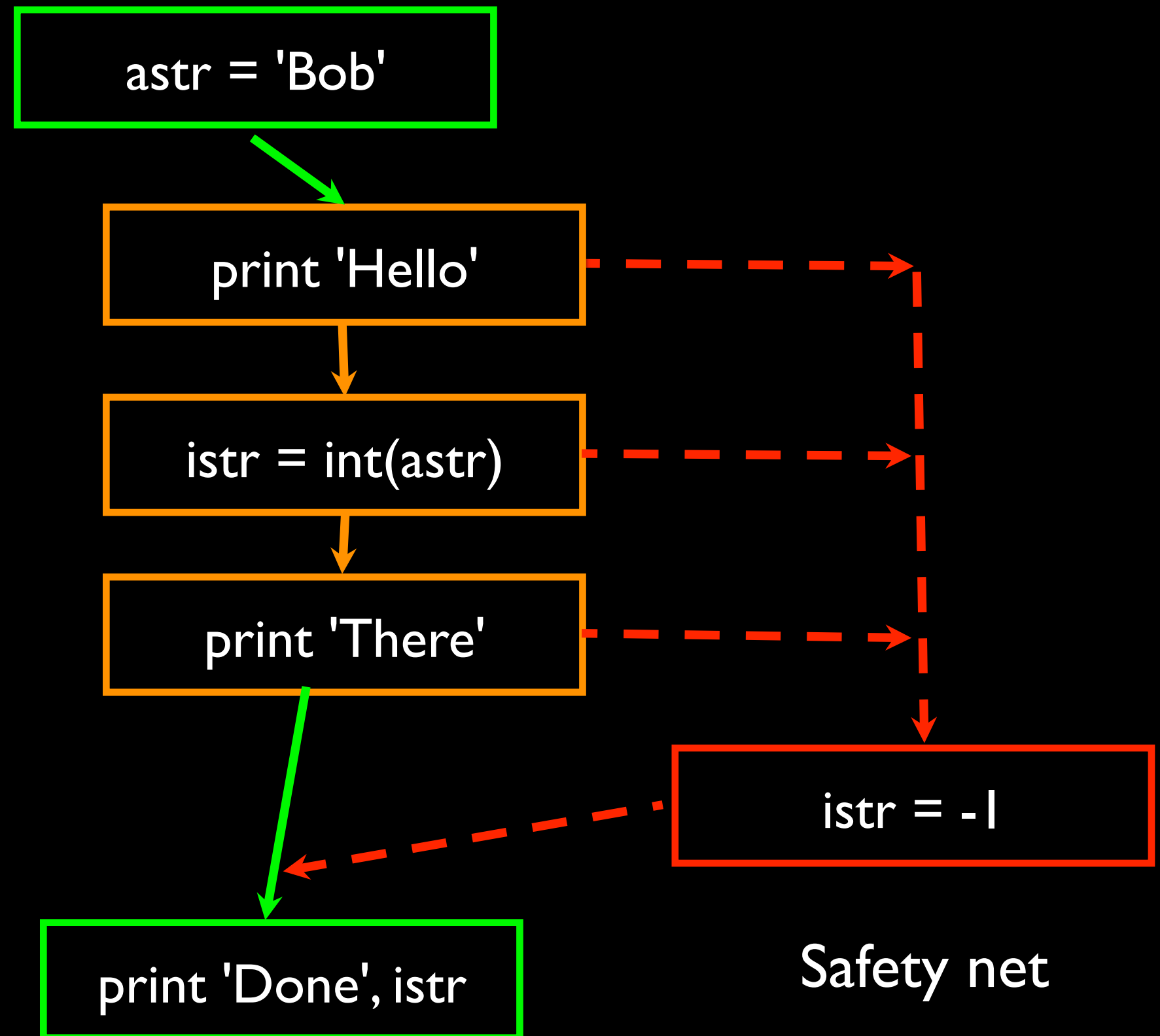

# Sample try / except

```
rawstr = raw_input('Enter a number:')
```

```
try:
```

```
    ival = int(rawstr)
```

```
except:
```

```
    ival = -1
```

```
if ival > 0 :
```

```
    print 'Nice work'
```

```
else:  
    print 'Not a number'
```

```
$ python trynum.py
```

```
Enter a number:42
```

```
Nice work
```

```
$ python trynum.py
```

```
Enter a number:fourtytwo
```

```
Not a number
```

```
$
```

## Exercise

Rewrite your pay computation to give the employee 1.5 times the hourly rate for hours worked above 40 hours.

Enter Hours: 45

Enter Rate: 10

Pay: 475.0

$$475 = 40 * 10 + 5 * 15$$

## Exercise

Rewrite your pay program using try and except so that your program handles non-numeric input gracefully.

Enter Hours: 20

Enter Rate: nine

Error, please enter numeric input

Enter Hours: forty

Error, please enter numeric input



# Summary

- Comparison operators == <= >= > < !=
- Logical operators: and or not
- Indentation
- One Way Decisions
- Two way Decisions if : and else :
- Nested Decisions
- Multiway decisions using elif
- Try / Except to compensate for errors